

Data Sheet

Motor actuator for ICM/ICMSTS motorized valves and CVE pilot valve Type **ICAD 600B/1200B** and **ICAD 600B-TS**

For precise and trouble-free control



ICAD actuators for direct control of ICM/ICMSTS motorized valves and CVE pilot valve.

ICAD actuator can be controlled in multiple ways:

- Using the following signals:
 - 0 – 20 mA
 - 4 – 20 mA
 - 0 – 10 V
 - 2 – 10 V
- By a digital input (on-off)
- Via data communication:
 - Modbus RTU (RS485)
 - Modbus TCP/IP (Ethernet)

Valve opening can be manually controlled with ICAD actuator.

The actuators ICAD 600B and 1200B are designed for ICM valves and CVE pilot. The actuator type 600B-TS is dedicated specifically for ICMSTS valves.

New design of flange connection for magnet coupling with ICM and ICMSTS valves. ICAD B series and the new mounting design for magnet coupling is 100% backwards compatible with previous ICAD generation.

ICAD B incorporates an advanced MMI (Man Machine Interface) display with descriptive text and icons, which gives the user a very intuitive, advanced and flexible set up procedure that can meet different applications.

In addition to the display interface, ICAD B also incorporates Bluetooth communication to a mobile app and data communication, which give the user alternative Interfaces for optimal efficiency and convenience when setting up an ICAD B.

Features

- Specifically designed for ICM and ICMTS valves
- Advanced and high speed Digital Stepper Motor Technology
- Additional micro steps to provide more precise control
- High contrast LCD display and user friendly navigation keyboard
- Valve opening degree can be observed continuously
- Can easily be configured to different applications on-site. (change speed, ON/OFF, modulating valve)
- Data connection via RS485 or Ethernet
- In addition to the onboard display, all configuration and readings from ICAD B actuators can be performed via Bluetooth (using Coolconfig mobile app) or via data communication
- Modulating or ON/OFF operation
- Multiple speed selection during operation
- Logging of all events, warnings and alarms
- Password protection
- Multiple control options: Analog signals (0–20 mA, 4–20 mA, 0–10 V, 2–10 V), digital signal (On-off) and data communication (RS485 & Ethernet)
- Position feedback: Signals (0–20 mA , 4–20 mA) and Data communication (Rs485 & Ethernet)
- 3 digital ON/OFF feedback
- Resolution: 20 micron/step (0.02 mm stroke pr. step)
- Auto Calibration
- In the event of a power failure, multiple fail safe options are possible. During power failure, ICAD can be selected to:
 - Stay in the position it was in, prior to power failure. Go to a specific valve opening degree
 - Close the valve
 - Open the valve
- Includes encoder function that provide a true valve position feedback to Danfoss controller or non-Danfoss control systems
- Hermetic magnetic motor
- New design of hermetic flange connection to secure highest reliability of magnet coupling
- Enclosure: IP 67 (~NEMA 6)
- Approvals: CE, UL
- Connectors for easy installation and servicing
- Automatic Autodetection of valve where is mounted
- Quick Set up wizard

Function

The design of ICAD is based on a digital stepper motor technology combined with an advanced MMI (Man Machine Interface), that gives excellent possibilities for having a high degree of flexibility with the same type of ICAD actuator.

The Opening Degree (0-100 %) of the actual ICM and ICMTS valves installed can be continuously observed on the ICAD display or the alternative interfaces (Mobile app and data communication).

The advanced menu system will allow several parameters to be adjusted to obtain the required function.

Many different parameters can be configured, among these:

- Modulating and ON/OFF control
- Analog input
 - 0 – 20 mA or 4 – 20 mA
 - 0 – 10 V or 2 – 10 V
- Analog output
 - 0 – 20 mA or 4 – 20 mA
- Automatic or manual control
- Change of ICM/ICMTS valve speed
- Automatic calibration
- Autodetection for valve size
- Multiple Fail Safe set-up options during power cut

For service all Input and Output signals can be recalled and observed from the ICAD display.

A password protection has been linked to the parameter of entering the correct ICM/ICMTS valve to avoid unintentional and non-authorized operation.

Product specification

Technical data

Table 1: Technical data - Actuator

Features	Specifications
Materials	Housing: Aluminium Top part of ICAD: PBT thermo plastic
Weight	ICAD 600B: 1.65 kg (3.64 lb) ICAD 1200B: 2.29 kg (5.05 lb) ICAD 600B-TS: 1.73 kg (3.81 lb)
Temperature range (ambient)	-30 °C / +50 °C (-22 °F / 122 °F)
Enclosure	IP 67 (~NEMA 6)
Cable connection	Cables not included. To be ordered separately M12 connectors
Supply cable	4 × 0.34 mm ² (3 × ~22 AWG) Ø4.8 mm (diameter 0.19")
Control cable	7 × 0.25 mm ² (7 × ~24 AWG) Ø6 mm (diameter 0.24")
Data communication cable	4 × 0.08 mm ² (4 × ~26 AWG) Ø6 mm (diameter 0.24")

Electrical data

Table 2: Electrical connections

Features	Specifications
Electrical data	Supply voltage is galvanic isolated from Input/Output
Supply voltage	Load: 24 V DC (Tolerances; see Table 3) ICAD 600B, ICAD 600B-TS: 1.2 A ICAD 1200B: 2.0 A
Fail safe supply	24 V DC (Tolerances; see Table 3) Load ICAD 600B, ICAD 600B-TS: 1.2 A ICAD 1200B: 2.0 A
Analog input	Current: Input range: 0/4 – 20 mA Max input range: 0 – 24 mA Input resistance: 120 Ω + diode voltage 0.7 V DC Measurement error: <±1.5% of the full scale Reverse polarity protection: yes Overcurrent protection: yes
	Voltage: Input range: 0/2 – 10 V DC Max input range: 0 – 12 V DC Measurement error: <±1.5% of the full scale Reverse polarity protection: yes
Analog output	Output range: 0/4 – 20 mA Load: <800 Ω Output error: <±1.5% of the full scale
Digital input	<i>Digital ON/OFF input by means of voltfree contact (Signal/Telecom relays with gold-plated contacts recommended) – Voltage input used</i> Rth rise(OFF): >10 kΩ Rth fall(ON): < 45 Ω
Digital output	3 pcs. NPN transistor output <i>External supply: 7 – 24 V DC (same supply as for ICAD can be used, but please note that the galvanically isolated system will then be spoiled).</i> <i>On resistance: 55 Ω + diode voltage 0.7 V DC Max 70 Ω at 50 mA</i> Max Output current: 50 mA Reverse polarity protection: Yes Overcurrent protection: No

Table 3: ICAD supply voltage tolerances

Prefabricated ICAD cable length Code number		1.5 m	3 m	10 m	15 m
		027H0426	027H0438	027H0427	027H0435
Voltage ICAD terminal (600B/1200B) [V DC]	Min.	21	22	23	24
	Max.	26.4			

Cable connection

Figure 1: Cable connection

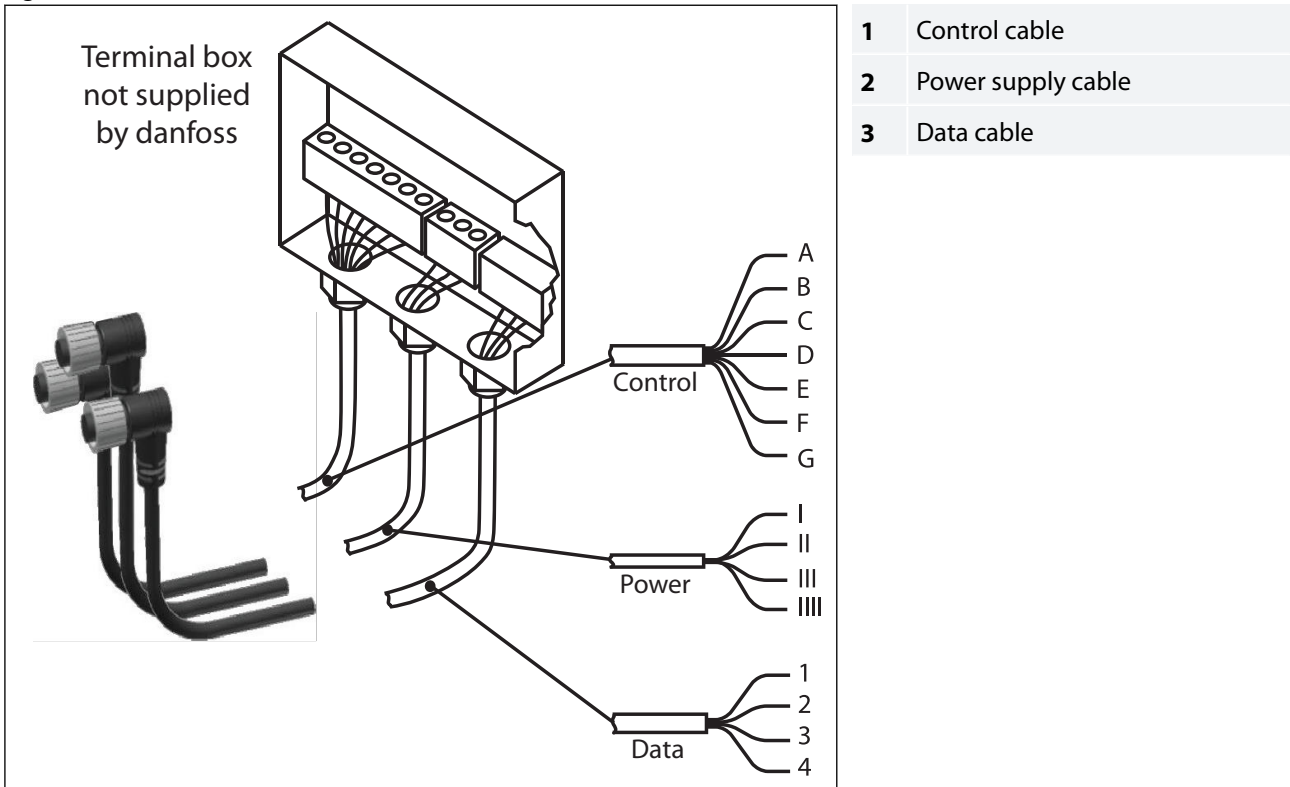
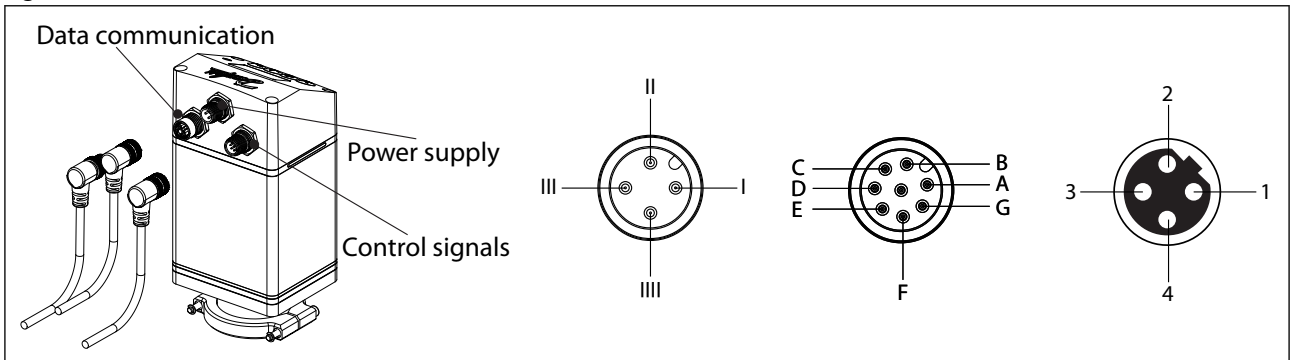

Figure 2: Cable Connectors - Rear view



Motor actuator for ICM/ICM-TS motorized valves

Figure 3: ICAD back Description

ICAD back	Ref	Color		Description	
	A	Black	-	Common alarm	} Digital output
	B	Brown	-	ICM fully open	
	C	Red	-	ICM fully closed	
	D	Orange	-	GND ground	
	E	Yellow	+	0/4 –20 mA Input	
	F	Green	+	0/2 –10 V input or digital input for on/off control	
	G	Blue	+	0/4 –20 mA Output	
	I	Black	+	Fail safe supply. Battery / UPS* 19 V DC	
	II	White	+	Supply voltage	
	III	Brown	-	24 V DC 2A, or more, per ICAD recommended ICAD PSU must be SELV**, >15 W	
	IIII	Blue	+	UPS Signal of Health - optional depending on ID31: 'UPS supply' set to 'Yes'	
RS485/ Ethernet					
	1	White/Blue	(-) / TX+	Data – (B) / Transmit Pair(+)	
	2	White/Orange	GND / RX+	Ground / Receiving Pair(+)	
	3	Blue	(+) / TX-	Data + (A) / Transmit Pair(-)	
	4	Orange	GND / RX-	Ground / Receiving Pair(-)	

***Uninterruptable Power Supply**
****The ICAD is a Class III appliance**

Fail Safe supply options

Figure 4: ICAD 600A-TS



In the event of a power failure, multiple fail safe options are possible, provided that a ICAD-UPS or similar is used.

During power failure, ICAD can be selected to:

- Close ICM/ICM-TS
- Open ICM/ICM-TS
- Stay in the position it was in, prior to power failure
- Go to a specific valve opening degree

Motor actuator for ICM/ICM-TS motorized valves

See ICAD-UPS for ICM/ICM-TS for further information.

i NOTE:

A fail safe supply (battery or UPS) is required.

ICAD-UPS for ICM and ICMTS valves

Figure 5: ICAD-UPS



ICAD-UPS is designed for using with ICM and ICMTS valves.

In the event of power failure, there is a need to make sure that the ICM/ICM-TS goes to a safe position. ICAD-UPS can be connected to the ICAD.

The solution of connecting ICMTS with ICAD to ICAD-UPS will give one of the following possibilities in the event of power failure:

- close ICM/ICM-TS
- open ICM/ICM-TS
- stay
- go to a specific ICM/ICM-TS Opening Degree

When power supply has been re-established the system will automatically return to normal operation.

Facts and features

- Industrial product
- Can support up to:
 - 3 pcs. of ICAD 1200B or
 - 8 pcs. of ICAD 600B or ICAD 600B-TS
- Integrated solution - battery and UPS
- Industrial approvals:
CE, UL, GL (Germanischer Lloyd)
- DIN rail mounting
 - LED indication
 - Green (Power ON)
 - Yellow (Flashing: charging, Constant: Buffer mode (Failsafe supply to ICAD 600A- TS))
 - Red (Battery fully discharged/Battery faulty)
- 24 V DC supply → Same transformer as for ICAD 600A-TS can be used. Only +0.5 A extra load on the transformer
- Check of battery every 60 sec
- Adjustable buffer time⁽¹⁾. (1, 2, 3, 5, 10, 15, 20, 30 or infinity) = Ensures longer battery life time
- Forced remote shutdown in buffer mode via digital input
- 3 digital volt free relay change over contacts for signals to PLC systems. (Power OK, Buffer mode (failsafe supply to ICAD), Alarm)

¹ Buffer time is defined as the period where ICAD is only powered from the ICAD-UPS (i.e. not from main supply). On ICAD-UPS there is an adjustable buffer time setting (1, 2, 3, 5, 10, 15, 20, 30 min. or infinity). If set to 3, ICAD-UPS will switch off power to connected ICAD 600A-TS, 3 minutes after the power failure occurs. This ensures that the internal battery inside ICAD-UPS does not fully discharge

Motor actuator for ICM/ICM-TS motorized valves

Code number: **027H0388**

For further information, please refer Instruction guide - [AN000086416706](#).

Applications

Figure 6: Separate 24 V DC transformer for both ICAD-UPS and ICAD

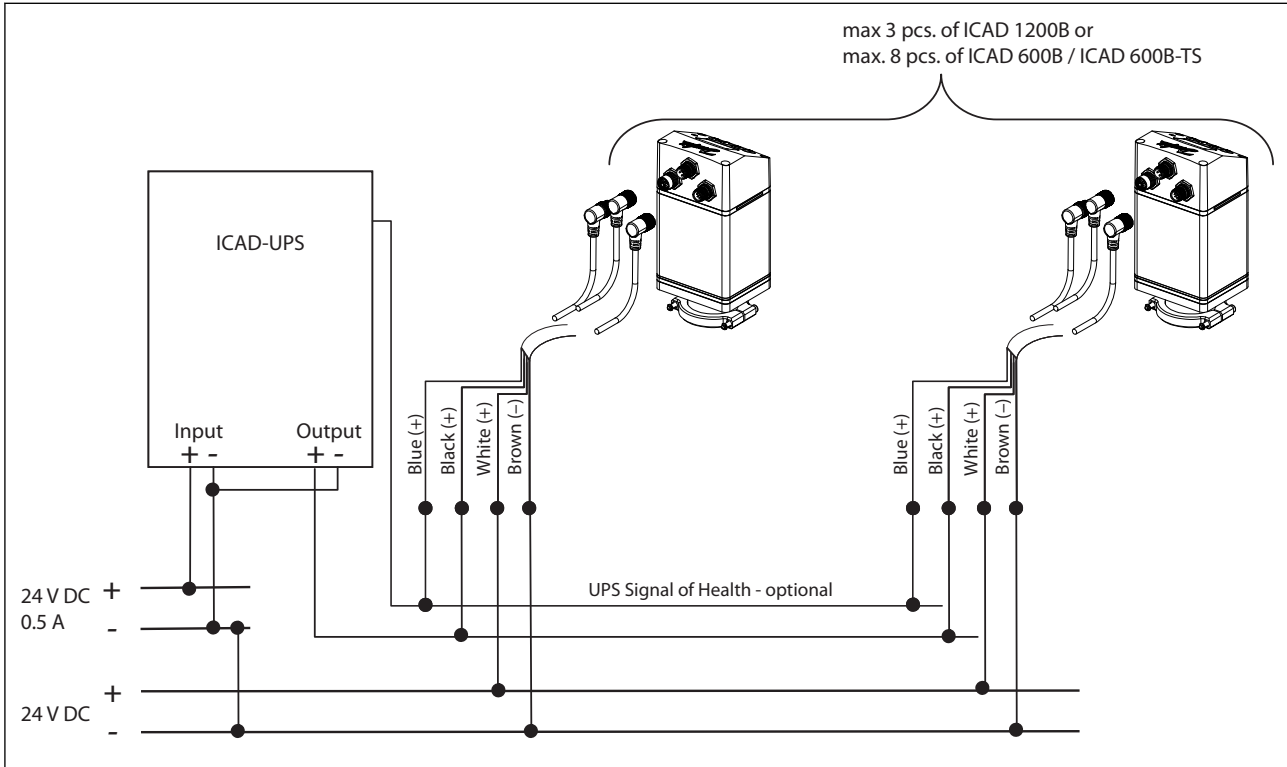
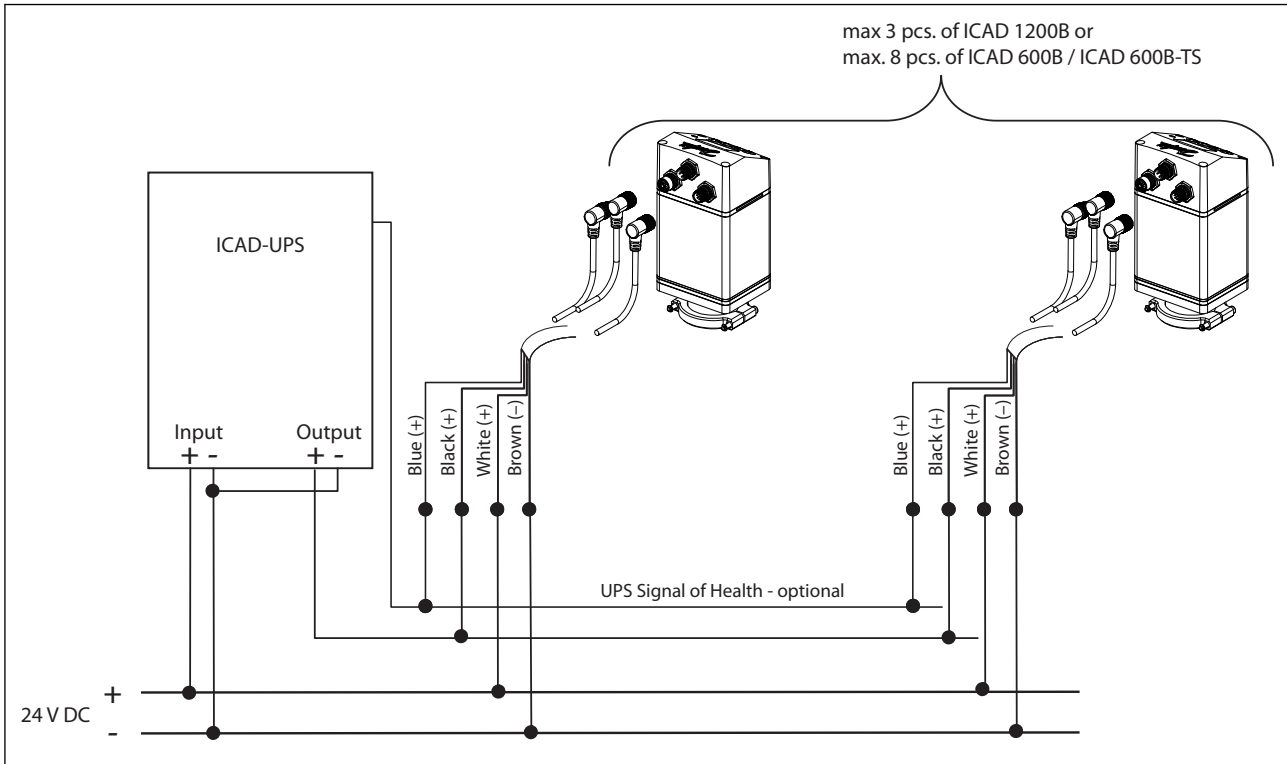

Figure 7: One 24 V DC transformer for ICAD-UPS and ICAD



General operation

ICAD actuators are equipped with multiple interfaces (onboard display, Bluetooth mobile app and data communication) from which it is possible to monitor and change the setting of parameters to adapt the actuator and the corresponding ICM and ICMTS valves to the actual refrigeration application.

ICAD light guide

In addition to the onboard display, ICAD B is equipped with an status light guide visible from different angles. The light guide provides a continuous status of ICAD B operation in real time.

Figure 8: ICAD light guide

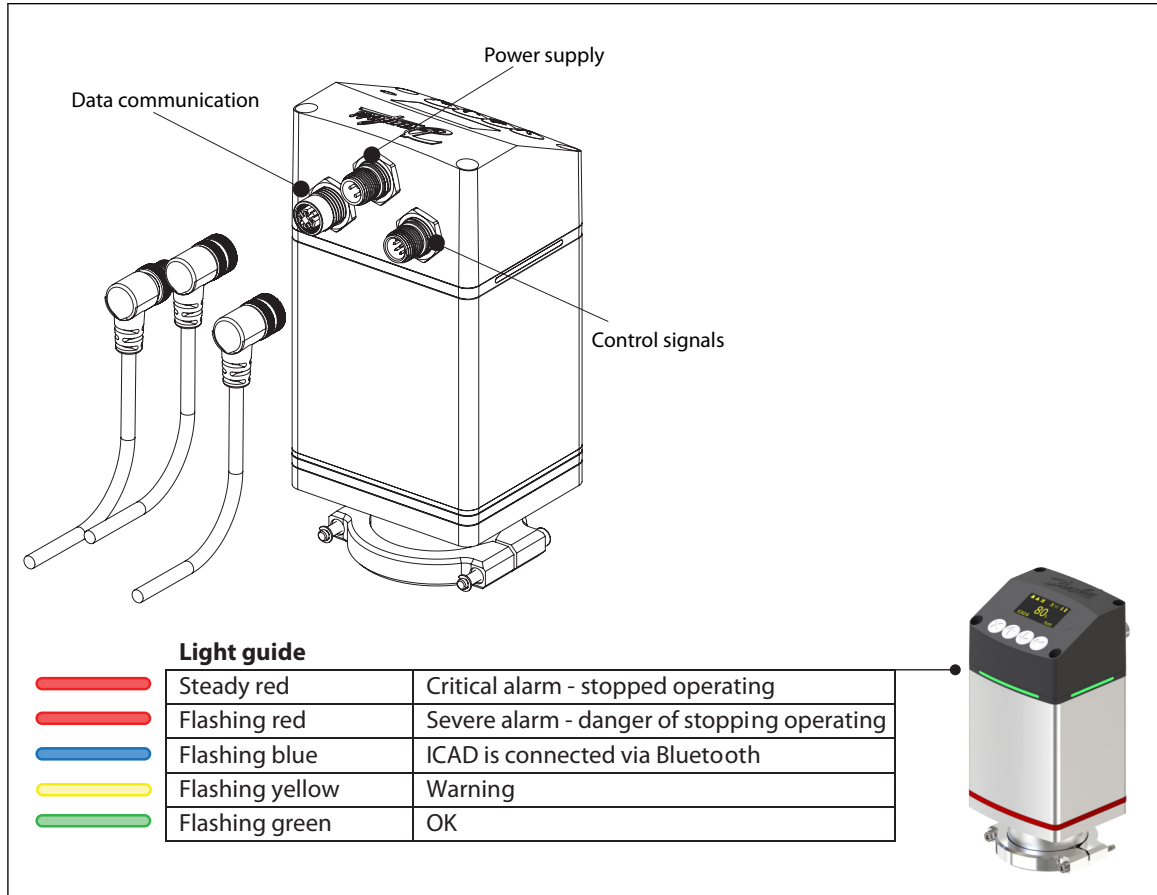

Status bar

The main screen layout and navigation is as described below. ICAD will start up in warning mode as the ICM configuration needs to be defined to start operation. Follow the steps on next page to set this up correctly.

1. To access the ICAD actuator menu, press ENTER button

Figure 9: STATUS BAR

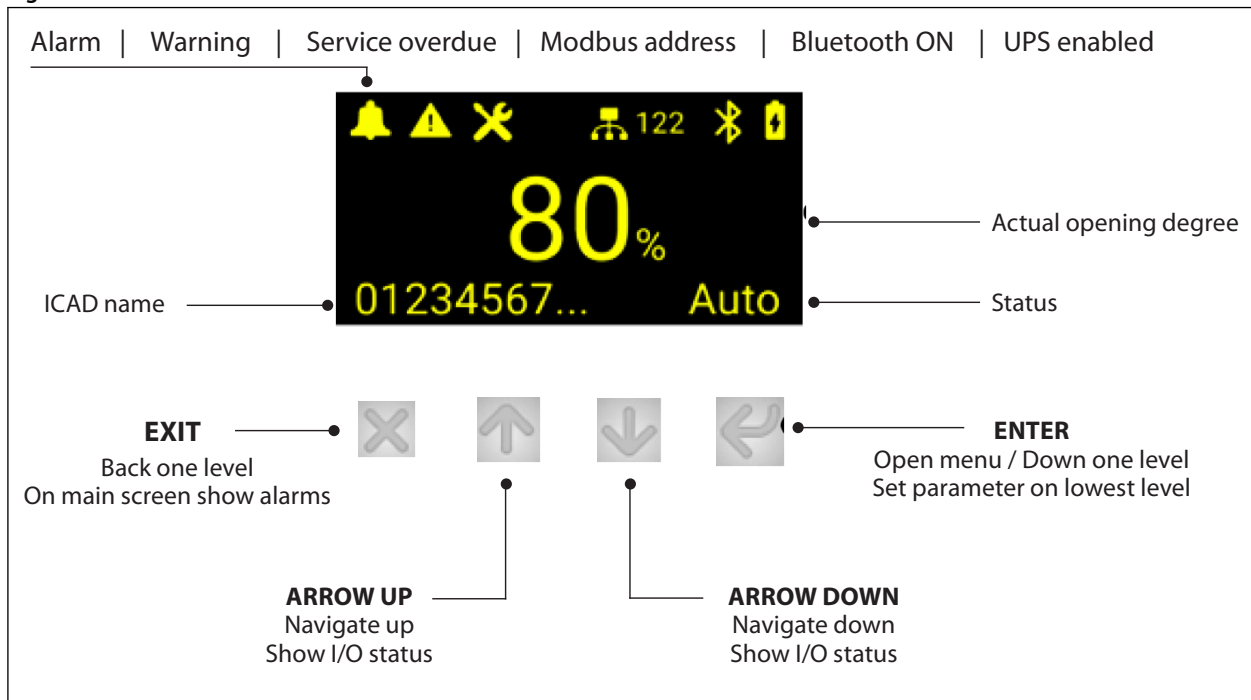

2. Once you are in the menu, use the UP and DOWN arrows to move through the list of parameters
3. To display and/or change the value of the parameter, press ENTER button to view the current settings
 - 3.1. To change the value of a parameter, use the up or down arrow to establish the new value for that parameter
 - 3.2. Once the new value for the parameter has been selected, press ENTER button to save the change and return to the menu
 - 3.3. Repeat this procedure for all parameters
 - 3.4. Exit from the parameter list by pressing EXIT button or simply wait for the ICAD to return to the main display (approx. 20 seconds)

Ordering

Depending on the valve type and size, there are three types of ICAD actuators (ICAD 600B, ICAD 1200B and ICAD 600B-TS). All three types are available in 4 different variants, with or without display and with communication via either Modbus RTU (RS485) or Modbus TCP/IP (Ethernet).

Figure 10: ICAD 1200B with display



Figure 11: ICAD 1200B without display

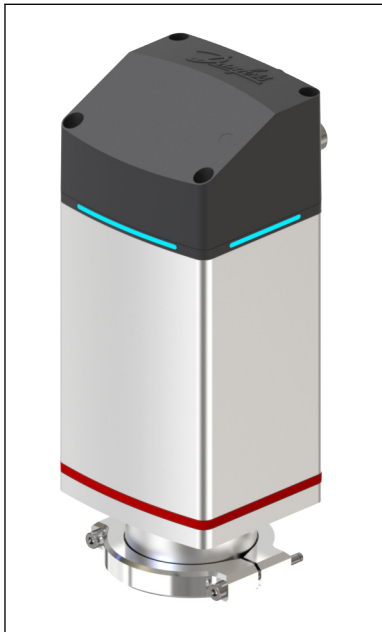

Figure 12: ICAD 600B

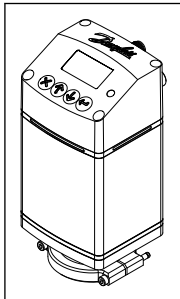
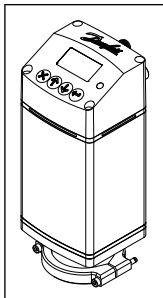

Table 4: ICAD 600B for ICM 20-32

Type	Code no.
ICAD 600B with display, Bluetooth, RS485	027H0485
ICAD 600B with display, Bluetooth, Ethernet	027H0486
ICAD 600B, without display, Bluetooth, RS485	027H0488
ICAD 600B, without display, Bluetooth, Ethernet	027H0489

Figure 13: ICAD 1200B



Motor actuator for ICM/ICM-TS motorized valves

Table 5: ICAD 1200B for ICM 40-150 and CVE

Type	Code no.
ICAD 1200B, with display, Bluetooth, RS485	027H0490
ICAD 1200B, with display, Bluetooth, Ethernet	027H0491
ICAD 1200B, without display, Bluetooth, RS485	027H0493
ICAD 1200B, without display, Bluetooth, Ethernet	027H0494

Figure 14: ICAD 600B-TS

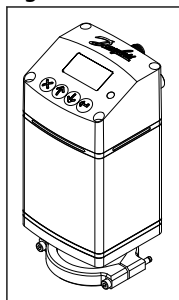

Table 6: ICAD 600B-TS for ICMTS 20-80

Type	Code no.
ICAD 600B-TS, with display, Bluetooth, RS485	027H0495
ICAD 600B-TS, with display, Bluetooth, Ethernet	027H0496
ICAD 600B-TS, without display, Bluetooth, Rs485	027H0498
ICAD 600B-TS, without display, Bluetooth, Ethernet	027H0499

Accessories

Cables should be ordered separately.

Figure 15: Cable for ICAD

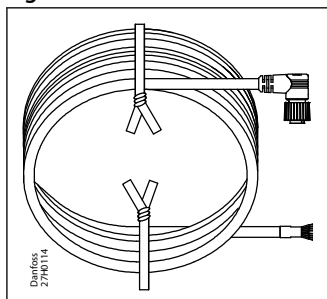

Table 7: ICAD B cable set with 3x cables (power supply, control signal and data communication)

Length	Code no.
ICAD B Cable set 1,5m (3x cables)	027H0464
ICAD B Cable set 3m (3x cables)	027H0465
ICAD B Cable set 10m (3x cables)	027H0466
ICAD B Cable set 15m (3x cables)	027H0467

Table 8: ICAD A and ICAD B cable set with 2x cables (power supply and control signal)

Length	Code no.
ICAD A and ICAD B Cable set 1,5m (2x cables)	027H0426
ICAD A and ICAD B Cable set 3,0m (2x cables)	027H0438
ICAD A and ICAD B Cable set 10m (2x cables)	027H0427
ICAD A and ICAD B Cable set 15m (2x cables)	027H0435

Table 9: Accessories

Type	Code no.
Service kit ICAD 600B (10 pcs of o-rings for magnetic coupling)	027H0428
Service kit ICAD 1200B and ICAD 600B-TS (10 pcs of o-rings for magnetic coupling)	027H0429

Figure 16: ICAD-UPS



Table 10: ICAD-UPS

Type	Code no.
ICAD-UPS	027H0388

Figure 17: ICAD Protection Cap

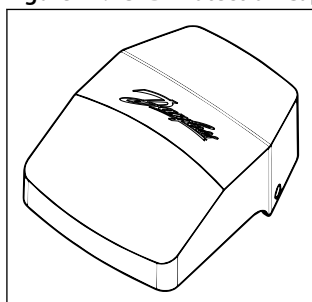

Table 11: ICAD Protection Cap

Type	Code no.
ICAD-B Protective cover	027H0468

Certificates, declarations and approvals

The list contains all certificates, declarations, and approvals for this product type. Individual code number may have some or all of these approvals, and certain local approvals may not appear on the list.

Some approvals may change over time. You can check the most current status at danfoss.com or contact your local Danfoss representative if you have any questions.

Table 12: ICAD B

File name	Document type	Document topic	Approvals Authority
E258350	Electrical - Safety Certificate	-	UL
027R0723	Manufacturers Declaration	FCC	Danfoss

Online support

Danfoss offers a wide range of support along with our products, including digital product information, software, mobile apps, and expert guidance. See the possibilities below.

The Danfoss Product Store



The Danfoss Product Store is your one-stop shop for everything product related—no matter where you are in the world or what area of the cooling industry you work in. Get quick access to essential information like product specs, code numbers, technical documentation, certifications, accessories, and more.

Start browsing at store.danfoss.com.

Find technical documentation



Find the technical documentation you need to get your project up and running. Get direct access to our official collection of data sheets, certificates and declarations, manuals and guides, 3D models and drawings, case stories, brochures, and much more.

Start searching now at www.danfoss.com/en/service-and-support/documentation.

Danfoss Learning



Danfoss Learning is a free online learning platform. It features courses and materials specifically designed to help engineers, installers, service technicians, and wholesalers better understand the products, applications, industry topics, and trends that will help you do your job better.

Create your Danfoss Learning account for free at www.danfoss.com/en/service-and-support/learning.

Get local information and support



Local Danfoss websites are the main sources for help and information about our company and products. Find product availability, get the latest regional news, or connect with a nearby expert—all in your own language.

Find your local Danfoss website here: www.danfoss.com/en/choose-region.

Spare Parts



Get access to the Danfoss spare parts and service kit catalog right from your smartphone. The app contains a wide range of components for air conditioning and refrigeration applications, such as valves, strainers, pressure switches, and sensors.

Download the Spare Parts app for free at www.danfoss.com/en/service-and-support/downloads.

Coolselector®2 - find the best components for you HVAC/R system



Coolselector®2 makes it easy for engineers, consultants, and designers to find and order the best components for refrigeration and air conditioning systems. Run calculations based on your operating conditions and then choose the best setup for your system design.

Download Coolselector®2 for free at coolselector.danfoss.com.

Danfoss A/S

Climate Solutions • danfoss.com • +45 7488 2222

Any information, including, but not limited to information on selection of product, its application or use, product design, weight, dimensions, capacity or any other technical data in product manuals, catalogues descriptions, advertisements, etc. and whether made available in writing, orally, electronically, online or via download, shall be considered informative, and is only binding if and to the extent, explicit reference is made in a quotation or order confirmation. Danfoss cannot accept any responsibility for possible errors in catalogues, brochures, videos and other material. Danfoss reserves the right to alter its products without notice. This also applies to products ordered but not delivered provided that such alterations can be made without changes to form, fit or function of the product.

All trademarks in this material are property of Danfoss A/S or Danfoss group companies. Danfoss and the Danfoss logo are trademarks of Danfoss A/S. All rights reserved.